

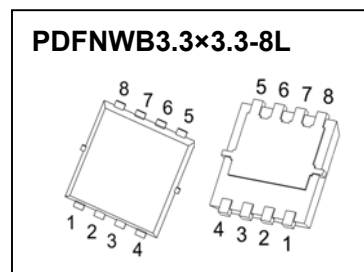

PDFNWB3.3×3.3-8L Plastic-Encapsulate MOSFETS

CJAB25N04S N-Channel Power MOSFET

$V_{(BR)DSS}$	$R_{DS(ON)TYP}$	I_D
40V	7.5mΩ@10V	25A
	10.5mΩ@4.5V	



DESCRIPTION

The CJAB25N04S uses advanced trench technology and design to provide excellent $R_{DS(ON)}$ with low gate charge. It can be used in a wide variety of applications

FEATURES

- High Power and current handing capability
- Load switch
- High density cell design for ultra low $R_{DS(ON)}$
- Lead free product is acquired
- Good stability and uniformity with high E_{AS}
- Excellent package for good heat dissipation

APPLICATIONS

- SMPS and general purpose applications
- Hard switched and high frequency circuits
- Uninterruptible Power Supply
- Power management

MARKING

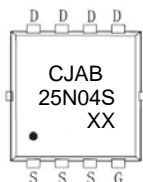

CJAB25N04S = Part No.
 Solid dot=Pin1 indicator
 XX=Code

EQUIVALENT CIRCUIT

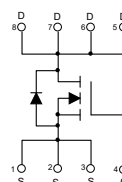

MAXIMUM RATINGS ($T_a=25^{\circ}C$ unless otherwise noted)

Parameter	Symbol	Limit	Unit
Drain-Source Voltage	V_{DS}	40	V
Gate-Source Voltage	V_{GS}	±20	V
Continuous Drain Current	I_D	25	A
Pulsed Drain Current	I_{DM}	110	A
Single Pulsed Avalanche Energy	$E_{AS}^{(1)}$	120	mJ
Power Dissipation	P_D	3	W
Thermal Resistance from Junction to Ambient	$R_{\theta JA}$	41.67	$^{\circ}C/W$
Junction Temperature	T_J	150	$^{\circ}C$
Storage Temperature Range	T_{stg}	-55 ~+150	$^{\circ}C$
Lead Temperature for Soldering Purposes(1/8" from case for 10s)	T_L	260	$^{\circ}C$

(1). E_{AS} condition: $V_{DD}=15V, L=0.1mH, R_G=25\Omega$, Starting $T_J = 25^{\circ}C$

(2).Mounted on a glass epoxy board of 25.4 mm x 25.4 mm x 0.8 mmt

MOSFET ELECTRICAL CHARACTERISTICS

$T_a=25^\circ\text{C}$ unless otherwise specified

Parameter	Symbol	Test Condition	Min	Typ	Max	Unit
Off characteristics						
Drain-source breakdown voltage	$V_{(BR)DSS}$	$V_{GS} = 0V, I_D = 250\mu A$	40			V
Zero gate voltage drain current	I_{DSS}	$V_{DS} = 30V, V_{GS} = 0V$			1	μA
Gate-body leakage current	I_{GSS}	$V_{DS} = 0V, V_{GS} = \pm 20V$			± 100	nA
On characteristics (note1)						
Gate-threshold voltage	$V_{GS(th)}$	$V_{DS} = V_{GS}, I_D = 250\mu A$	1.0	1.7	2.5	V
Static drain-source on-state resistance	$R_{DS(on)}$	$V_{GS} = 10V, I_D = 10A$		7.5	9.4	$m\Omega$
		$V_{GS} = 4.5V, I_D = 10A$		10.5	15	$m\Omega$
Forward transconductance	g_{fs}	$V_{DS} = 10V, I_D = 2A$		15		S
Dynamic characteristics (note 2)						
Input capacitance	C_{iss}	$V_{DS} = 25V, V_{GS} = 0V,$ $f = 1MHz$		1200		pF
Output capacitance	C_{oss}			124		
Reverse transfer capacitance	C_{rss}			58		
Switching characteristics (note 2)						
Total gate charge	Q_g	$V_{DS} = 20V, V_{GS} = 10V,$ $I_D = 10A$		20.3		nC
Gate-source charge	Q_{gs}			3.2		
Gate-drain charge	Q_{gd}			5.0		
Turn-on delay time	$t_{d(on)}$	$V_{DS} = 15V, I_D = 10A,$ $V_{GS} = 10V, R_G = 3\Omega$		12.7		ns
Turn-on rise time	t_r			2.7		
Turn-off delay time	$t_{d(off)}$			57		
Turn-off fall time	t_f			4.8		
Drain-Source Diode Characteristics						
Drain-source diode forward voltage(note1)	V_{SD}	$V_{GS} = 0V, I_S = 10A$			1.2	V
Continuous drain-source diode forward current	I_S				25	A
Pulsed drain-source diode forward current	I_{SM}				100	A

Notes:

1. Pulse Test : Pulse Width $\leq 300\mu s$, duty cycle $\leq 2\%$.
2. Guaranteed by design, not subject to production.

Typical Characteristics

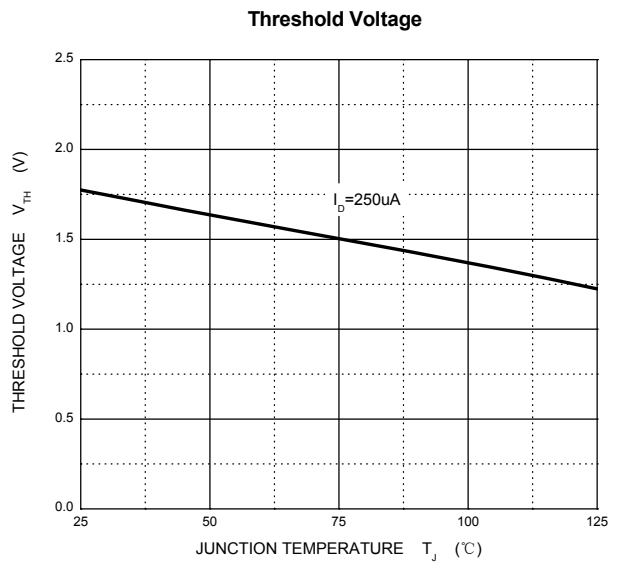
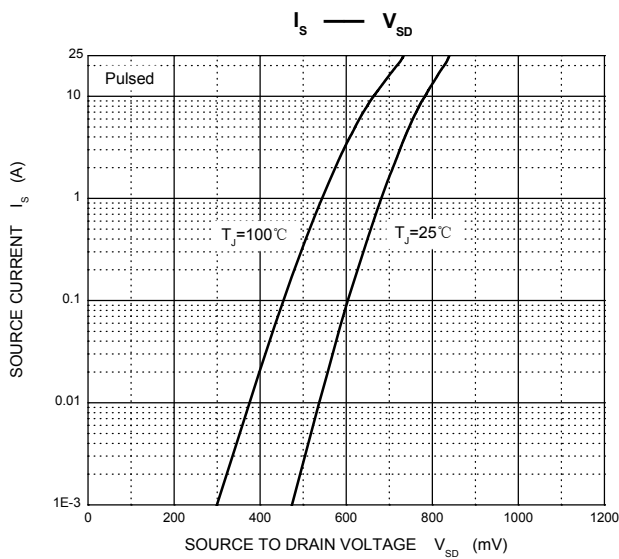
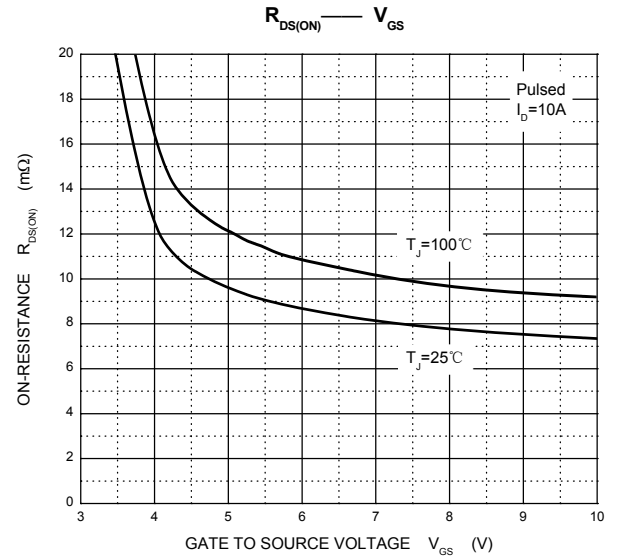
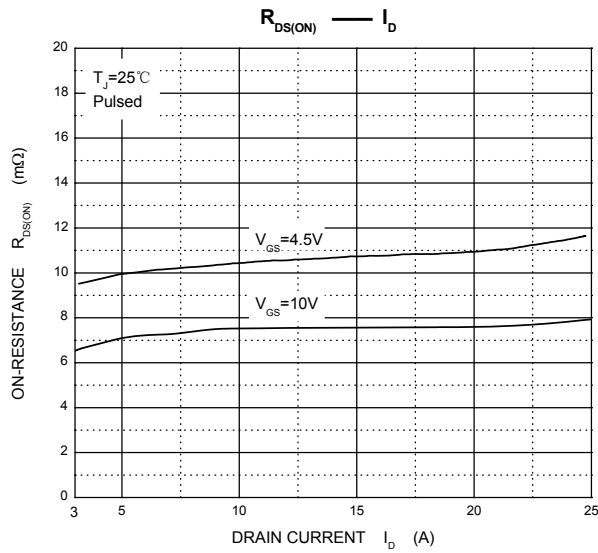
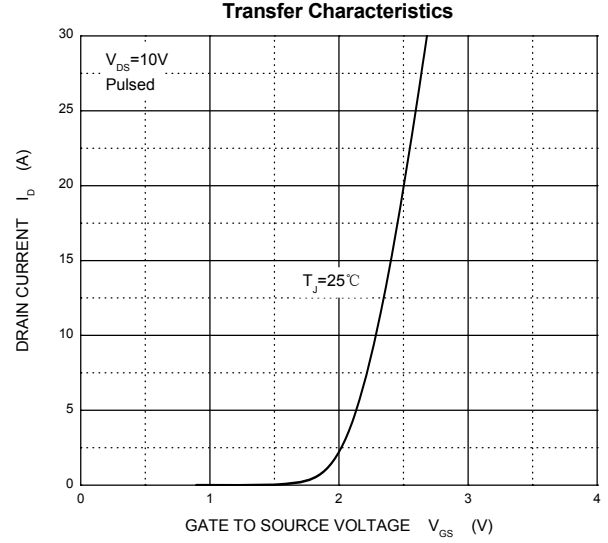
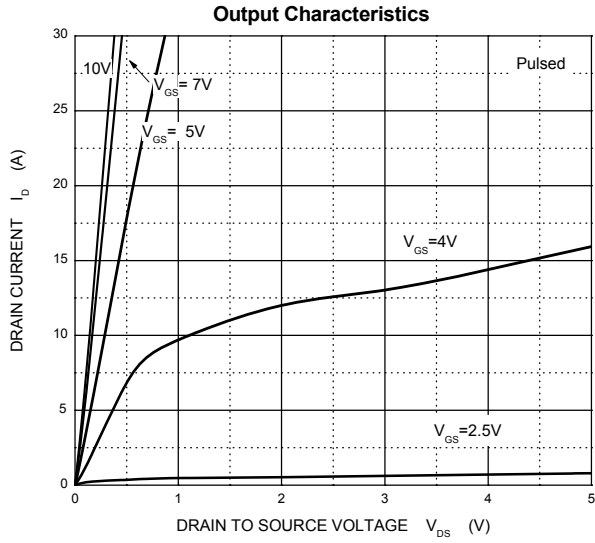

PDFNWB3.3x3.3-8L Package Outline Dimensions

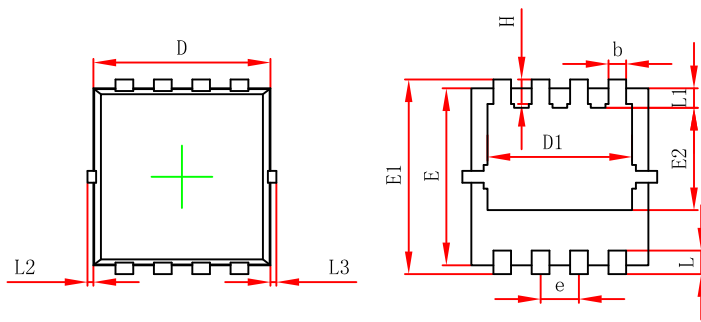

Top View
[顶视图]

Bottom View
[背视图]

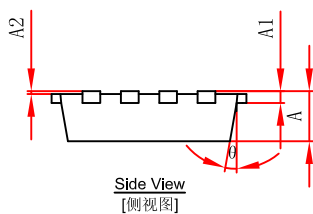

Side View
[侧视图]

Symbol	Dimensions In Millimeters		Dimensions In Inches	
	Min.	Max.	Min.	Max.
A	0.650	0.850	0.026	0.033
A1	0.152 REF.		0.006 REF.	
A2	0-0.05		0-0.002	
D	2.900	3.100	0.114	0.122
D1	2.300	2.600	0.091	0.102
E	2.900	3.100	0.114	0.122
E1	3.150	3.450	0.124	0.136
E2	1.535	1.935	0.060	0.076
b	0.200	0.400	0.008	0.016
e	0.550	0.750	0.022	0.030
L	0.300	0.500	0.012	0.020
L1	0.180	0.480	0.007	0.019
L2	0-0.100		0-0.004	
L3	0-0.100		0-0.004	
H	0.315	0.515	0.012	0.020
θ	9°	13°	9°	13°

PDFNWB3.3x3.3-8L Suggested Pad Layout

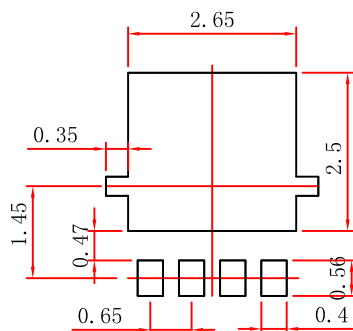

Note:

1. Controlling dimension: in millimeters.
2. General tolerance: ± 0.05 mm.
3. The pad layout is for reference purposes only.

NOTICE

JSCJ reserves the right to make modifications, enhancements, improvements, corrections or other changes without further notice to any product herein. JSCJ does not assume any liability arising out of the application or use of any product described herein.

PDFNWB3.3×3.3-8L Tape and Reel

PDFNWB3.3×3.3-8L Embossed Carrier Tape

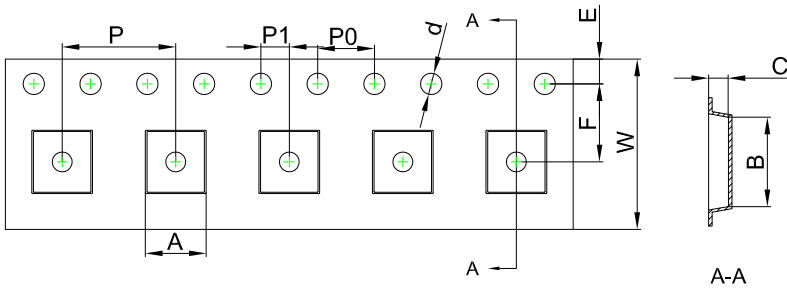

Packaging Description:

PDFNWB3.3×3.3-8L parts are shipped in tape. The carrier tape is made from a dissipative (carbon filled) polycarbonate resin. The cover tape is a multilayer film (Heat Activated Adhesive in nature) primarily composed of polyester film, adhesive layer, sealant, and anti-static sprayed agent. These reeled parts in standard option are shipped with 5,000 units per 13" or 33.0 cm diameter reel. The reels are clear in color and is made of polystyrene plastic (anti-static coated).

Dimensions are in millimeter										
Pkg type	A	B	C	d	E	F	P0	P	P1	W
PDFNWB3.3×3.3-8L	3.55	3.55	1.10	Ø1.50	1.75	5.50	4.00	8.00	2.00	12.00

PDFNWB3.3×3.3-8L Tape Leader and Trailer

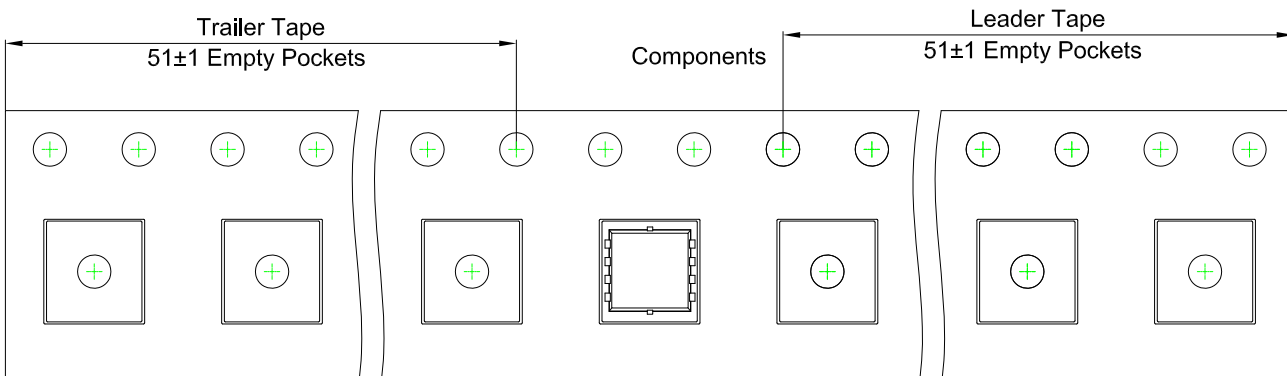

PDFNWB3.3×3.3-8L Reel

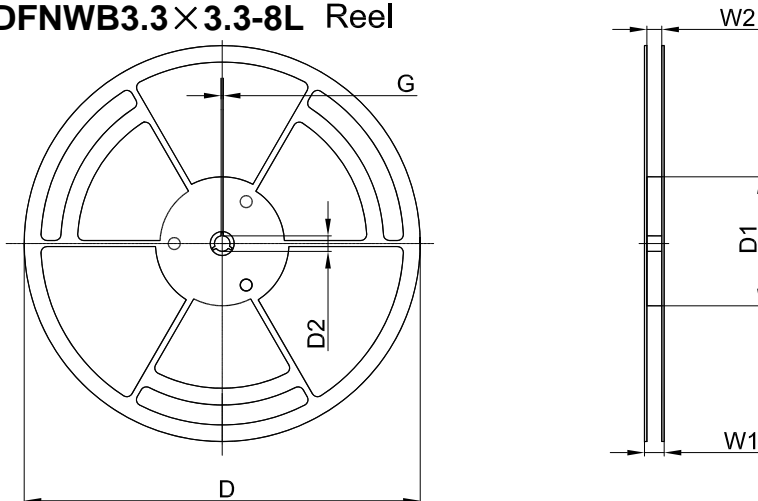

Dimensions are in millimeter						
Reel Option	D	D1	D2	G	W1	W2
13" Dia	Ø330.00	100.00	13.00	1.90	17.60	12.40

REEL	Reel Size	Box	Box Size(mm)	Carton	Carton Size(mm)
5,000 pcs	13 inch	5,000 pcs	340×336×29	50,000 pcs	353×346×365